

EVERLAST

POWER I –MIG SERIES **MIG/GMAW AND MMA/SMAW** **WELDERS**

Operator's Manual for Power i-MIG Welders



Safety, Setup and General Use Guide

THANK YOU FOR PURCHASING AN EVERLAST PRODUCT. WE APPRECIATE YOUR PATRONAGE AND HOPE THAT YOU WILL ENJOY YEARS OF USE FROM OUR PRODUCT.

PLEASE GO DIRECTLY TO THE EVERLAST WEBSITE TO REGISTER YOUR UNIT AND RECEIVE YOUR WARRANTY INFORMATION. YOUR UNIT REGISTRATION IS IMPORTANT SHOULD ANY INFORMATION SUCH AS PRODUCT UPDATES OR RECALLS BE ISSUED. IT IS ALSO IMPORTANT SO THAT WE MAY TRACK YOUR SATISFACTION WITH EVERLAST PRODUCTS AND SERVICES. IF YOU ARE UNABLE TO REGISTER BY WEBSITE, CONTACT EVERLAST DIRECTLY THROUGH THE CONSUMER DEPARTMENT AT THE MAIN NUMBER. YOUR UNIT WILL BE REGISTERED AND WARRANTEE WILL BE ISSUED AND IN FULL EFFECT.

Serial number: _____
Model number: _____
Date of Purchase _____

EVERLAST

Contact Information

Everlast consumer satisfaction email: sales@everlastwelders.com

Everlast Website: everlastwelders.com

Everlast Technical Support: Support@everlastwelders.com

Main toll free number: 1-877-755 WELD (9353) 9am—5pm PST M-F
11am-4pm PST Sat.

FAX: 1-650-588-8817

NOTES:

TABLE OF CONTENTS

Section.....	Page
General	5
Safety Precautions.....	6
Introduction.....	9
1.6 Performance Specifications.....	9
1.7 Welding Wire Selection.....	9
1.8 Shielding Gas Information.....	9
Know Your Machine.....	10
2.2 Machine Face and Functions.....	10
2.3 Machine Rear and Functions.....	12
2.4 Wire Feeder Mechanism.....	13
Getting Started.....	15
3.1 General Guidelines.....	15
3.2 Shielding Gas Selection.....	15
3.3 Regulator/Flow meter Selection.....	15
3.4 Regulator Connection.....	15
3.5 Regulator Adjustment.....	15
3.6 Machine Setup.....	16
3.7 Machine Operation MIG.....	17
3.8 Machine Operation MMA.....	18
Trouble Shooting.....	19
Parts and Accessories.....	20

GENERAL

Everlast is dedicated to providing you with the best possible equipment and service to meet the demanding jobs that you have. We want to go beyond delivering a satisfactory product to you. That is the reason we offer technical support to assist you with your needs should an occasion occur. With proper use and care your product should deliver years of trouble free service.



Safe operation and proper maintenance is your responsibility.

We have compiled this operator's manual, to instruct you in basic safety, operation and maintenance of your Everlast product to give you the best possible experience. Much of welding and cutting is based upon experience and common sense. As thorough as this welding manual may be, it is no substitute for either. Exercise extreme caution and care in all activities related to welding or cutting. Your safety, health and even life depends upon it. While accidents are never planned, preventing an accident requires careful planning.

Please carefully read this manual before you operate your Everlast unit. This manual is not only for the use of the machine, but to assist in obtaining the best performance out of your unit. Do not operate the unit until you have read this manual and you are thoroughly familiar with the safe operation of the unit. If you feel you need more information please contact Everlast Support.

The warranty does not cover improper use, maintenance or consumables. **Do not attempt to alter or defeat any piece or part of your unit, particularly any safety device.** Keep all shields and covers in place during unit operation should an unlikely failure of internal components result in the possible presence of sparks and explosions. If a failure occurs, discontinue further use until malfunctioning parts or accessories have been repaired or replaced by qualified personnel.



Note on High Frequency electromagnetic disturbances:

Certain welding and cutting processes generate High Frequency (HF) waves. These waves may disturb sensitive electronic equipment such as televisions, radios, computers, cell phones, and related equipment. High Frequency may also interfere with fluorescent lights. Consult with an electrician if disturbance is noted. Sometimes, improper wire routing or poor shielding may be the cause.



HF can interfere with pacemakers. See EMF warnings in following safety section for further information. Always consult your physician before entering an area known to have welding or cutting equipment if you have a pacemaker.

SAFETY PRECAUTIONS



These safety precautions are for protection of safety and health. Failure to follow these guidelines may result in serious injury or death. Be careful to read and follow all cautions and warnings. Protect yourself and others.



Welding and cutting processes produce high levels of ultraviolet (UV) radiation that can cause severe skin burn and damage. There are other potential hazards involved with welding such as severe burns and respiratory related illnesses. Therefore observe the following to minimize potential accidents and injury:



Use appropriate safety glasses with wrap around shields while in the work area, even under welding helmets to protect your eyes from flying sparks and debris. When chipping slag or grinding, goggles and face shields may be required.



When welding or cutting, always use an approved shielding device, with the correct shade of filter installed. Always use a welding helmet in good condition. Discard any broken or cracked filters or helmets. Using broken or cracked filters or helmets can cause severe eye injury and burn. Filter shades of no less than shade 5 for cutting and no less than shade 9 for welding are highly recommended. Shades greater than 9 may be required for high amperage welds. Keep filter lenses clean and clear for maximum visibility. It is also advisable to consult with your eye doctor should you wear contacts for corrective vision before you wear them while welding.



Do not allow personnel to watch or observe the welding or cutting operation unless fully protected by a filter screen, protective curtains or equivalent protective equipment. If no protection is available, exclude them from the work area. Even brief exposure to the rays from the welding arc can damage unprotected eyes.



Always wear hearing protection because welding and cutting can be extremely noisy. Ear protection is necessary to prevent hearing loss. Even prolonged low levels of noise has been known to create long term hearing damage. Hearing protection also further protects against hot sparks and debris from entering the ear canal and doing harm.



Always wear personal protective clothing. Flame proof clothing is required at all times. Sparks and hot metal can lodge in pockets, hems and cuffs. Make sure loose clothing is tucked in neatly. Leather aprons and jackets are recommended. Suitable welding jackets and coats may be purchased made from fire proof material from welding supply stores. Discard any burned or frayed clothing. Keep clothing away from oil, grease and flammable liquids.



Leather boots or steel toed leather boots with rubber bottoms are required for adequate foot protection. Canvas, polyester and other man made materials often found in shoes will either burn or melt. Rubber or other non conductive soles are necessary to help protect from electrical shock.



Flame proof and insulated gauntlet gloves are required whether welding or cutting or handling metal. Simple work gloves for the garden or chore work are not sufficient. Gauntlet type welding gloves are available from your local welding supply companies. Never attempt to weld with out gloves. Welding with out gloves can result in serious burns and electrical shock. If your hand or body parts comes into contact with the arc of a plasma cutter or welder, instant and serious burns will occur. **Proper hand protection is required at all times when working with welding or cutting machines!**

SAFETY PRECAUTIONS

continued



WARNING! Persons with pacemakers should not weld, cut or be in the welding area until they consult with their physician. Some pacemakers are sensitive to EMF radiation and could severely malfunction while welding or while being in the vicinity of someone welding. *Serious injury or death may occur!*



Welding and plasma cutting processes generate electro-magnetic fields and radiation. While the effects of EMF radiation are not known, it is suspected that there may be some harm from long term exposure to electromagnetic fields. Therefore, certain precautions should be taken to minimize exposure:

- Lay welding leads and lines neatly away from the body.
- Never coil cables around the body.
- Secure cables with tape if necessary to keep from the body.
- Keep all cables and leads on the same side the body.
- Never stand between cables or leads.
- Keep as far away from the power source (welder) as possible while welding.
- Never stand between the ground clamp and the torch.
- Keep the ground clamp grounded as close to the weld or cut as possible.



Welding and cutting processes pose certain inhalation risks. Be sure to follow any guidelines from your chosen consumable and electrode suppliers regarding possible need for respiratory equipment while welding or cutting. Always weld with adequate ventilation. Never weld in closed rooms or confined spaces. Fumes and gases released while welding or cutting may be poisonous. Take precautions at all times. Any burning of the eyes, nose or throat are signs that you need to increase ventilation.

- Stop immediately and relocate work if necessary until adequate ventilation is obtained.
- Stop work completely and seek medical help if irritation and discomfort persists.



WARNING! Do not weld on galvanized steel, stainless steel, beryllium, titanium, copper, cadmium, lead or zinc without proper respiratory equipment and or ventilation.



WARNING! This product when used for welding or cutting produces fumes and gases which contains chemicals known to the State of California to cause birth defects and in some cases cancer. (California Safety and Health Code §25249.5 *et seq.*)



WARNING! Do not weld or cut around Chlorinated solvents or degreasing areas. Release of Phosgene gas can be deadly. Consider all chemicals to have potential deadly results if welded on or near metal containing residual amounts of chemicals.



Keep all cylinders upright and chained to a wall or appropriate holding pen. Certain regulations regarding high pressure cylinders can be obtained from OSHA or local regulatory agency. Consult also with your welding supply company in your area for further recommendations. The regulatory changes are frequent so keep informed.



All cylinders have a potential explosion hazard. When not in use, keep capped and closed. Store chained so that overturn is not likely. Transporting cylinders incorrectly can lead to an explosion. Do not attempt to adapt regulators to fit cylinders. Do not use faulty regulators. Do not allow cylinders to come into contact with work piece or work. Do not weld or strike arcs on cylinders. Keep cylinders away from direct heat, flame and sparks.

SAFETY PRECAUTIONS

continued



WARNING! Electrical shock can kill. Make sure all electrical equipment is properly grounded. Do not use frayed, cut or otherwise damaged cables and leads. Do not stand, lean or rest on ground clamp. Do not stand in water or damp areas while welding or cutting. Keep work surface dry. Do not use welder or plasma cutter in the rain or in extremely humid conditions. Use dry rubber soled shoes and dry gloves when welding or cutting to insulate against electrical shock. Turn machine on or off only with gloved hand. Keep all parts of the body insulated from work, and work tables. Keep away from direct contact with skin against work. If tight or close quarters necessitates standing or resting on work piece, insulate with dry boards and rubber mats designed to insulate the body from direct contact.



All work cables, leads, and hoses pose trip hazards. Be aware of their location and make sure all personnel in area are advised of their location. Taping or securing cables with appropriate restraints can help reduce trips and falls.



WARNING! Fire and explosions are real risks while welding or cutting. Always keep fire extinguishers close by and additionally a water hose or bucket of sand. Periodically check work area for smoldering embers or smoke. It is a good idea to have someone help watch for possible fires while you are welding. Sparks and hot metal may travel a long distance. They may go into cracks in walls and floors and start a fire that would not be immediately visible. Here are some things you can do to reduce the possibility of fire or explosion:

- Keep all combustible materials including rags and spare clothing away from area.
- Keep all flammable fuels and liquids stored separately from work area.
- Visually inspect work area when job is completed for the slightest traces of smoke or embers.
- If welding or cutting outside, make sure you are in a cleared off area, free from dry tender and debris that might start a forest or grass fire.
- Do not weld on tanks, drums or barrels that are closed, pressurized or anything that held flammable liquid or material.



Metal is hot after welding or cutting! Always use gloves and or tongs when handling hot pieces of metal. Remember to place hot metal on fire-proof surfaces after handling. Serious burns and injury can result if material is improperly handled.



WARNING! Faulty or poorly maintained equipment can cause injury or death. Proper maintenance is your responsibility. Make sure all equipment is properly maintained and serviced by qualified personnel. Do not abuse or misuse equipment. Keep all covers in place. A faulty machine may shoot sparks or may have exploding parts. Touching uncovered parts inside machine can cause discharge of high amounts of electricity. **Do not allow employees to operate poorly serviced equipment.** Always check condition of equipment thoroughly before start up. Disconnect unit from power source before any service attempt is made and for long term storage or electrical storms.



Further information can be obtained from The American Welding Society (AWS) that relates directly to safe welding and plasma cutting. Additionally, your local welding supply company may have additional pamphlets available concerning their products. Do not operate machinery until your are comfortable with proper operation and are able to assume inherent risks of cutting or welding.

1.1 This manual has been compiled to give an overview of operation and is designed to offer information centered around safe, practical use of the machine. It is not intended to teach welding technique. All suggestions and techniques given are approximations and should be used as a general guide only.

1.2 To ensure that your Everlast product is in top condition, carefully inspect unit for damage upon opening the box, looking for damage on the surface of the unit and to the machine itself and all its accessories. Record the serial number on the page provided in this manual. Include purchase date for warranty reference. Serial numbers are located on the rear of the machine.

1.3 The Power i-Mig unit is capable of performing day to day fabrication and repair activities. The exceptional arc characteristics are provided by the inverter based technology that employs the use of reliable IGBT transistors from Germany. Light-weight inverters allow a machine to be finely tuned for precise arc characteristics, while consuming less power than the larger transformer based machines.



1.4 Be careful to observe duty cycles of the machine posted in this manual and on the machine itself.

A duty cycle is a rating of percentage of time out of 10 minutes the machine can be used at the rated power setting. Overheating of the machine and damage may occur if the duty cycle is exceeded.

1.5 Basic performance specifications of the Power i-MIG:

Suggested temperature operating range: 32°F(0° C) to 104°F (40° C)

Input voltage:
220-240 V; 50-60Hz

Input current:
34 Amps

Open current Voltage:
55-75 VDC ; Target: 60 VDC.

Operating/Work Voltage:
14-26 VDC \pm 3 V

Current output range:
40-200 Amps (GMAW/MIG)
40-160 Amps (SMAW/Stick/MMA)

Duty Cycle @ 40° C:
35% @ 200A/ 24 VDC
60% @ 155A/ 21.8 VDC
100% @ 120A/ 20 VDC

1.6 Wire selection and information:
This machine uses any standard quality MIG type solid steel wire. You may select and use any AWS classification wire intended for steel in these wire sizes:

.030" (.08 mm) diameter wire Min.
.035 "(1 mm) diameter wire Max.

Roll diameter:
12 inches Max.

AWS ER 70S-6 is a good wire for all around use and ease of weld. It is recommended that you do not use low quality wire brands and varieties that tend to "flake" or leave deposits inside the MIG gun liner. Copper coated steel wire may be used if it is of good quality. It is recommended for heavily oxidized welding surfaces and for welding machines that will not be used daily/ weekly. Be advised copper coated steel wire may leave deposits over time causing wire feed issues. Keep all wire and consumables dry! If you are unfamiliar with other AWS wire classifications, it is recommended that you consult with your local welding supplier to determine suitability of a particular wire for your application.

1.7 MIG shielding gas information:
Use blended Argon/CO2 gas for best results. 100% CO2 is only used for low value welds. A 75/25 Ar/CO2 mix is the most versatile and most common mixture. Other mixes are available such as 85/15 Ar/CO2 to further improve weld quality. Do not use pure Argon on mild steel.



Do not attempt to weld without a shielding gas unless a flux cored wire is used.

SECTION 2

KNOW YOUR MACHINE

2.1 It is important that you familiarize yourself with your machine before you start welding. Do not attempt to weld or otherwise operate the unit until you are familiar with the function of the basic components of the machine. Refer to the following section in order to understand basic component operation.

2.2 Image 2a is the front of the machine. Each item is referenced by number to the a function or control with following discussion of function of each item.

4. Power indicator. After turning machine on, (see section 2.3 for instructions) light should glow to indicate the machine is operational.

5. Polarity and ground selection lugs. In MIG mode, Cable 8 and ground cable are used to plug into ports 5 and 5a . Correct use of polarity is key to weld quality . Follow the electrode and wire manufacturers recommendations for polarity. In MMA / Stick mode, the ground and the electrode holder cables are inserted into 5 and 5a.

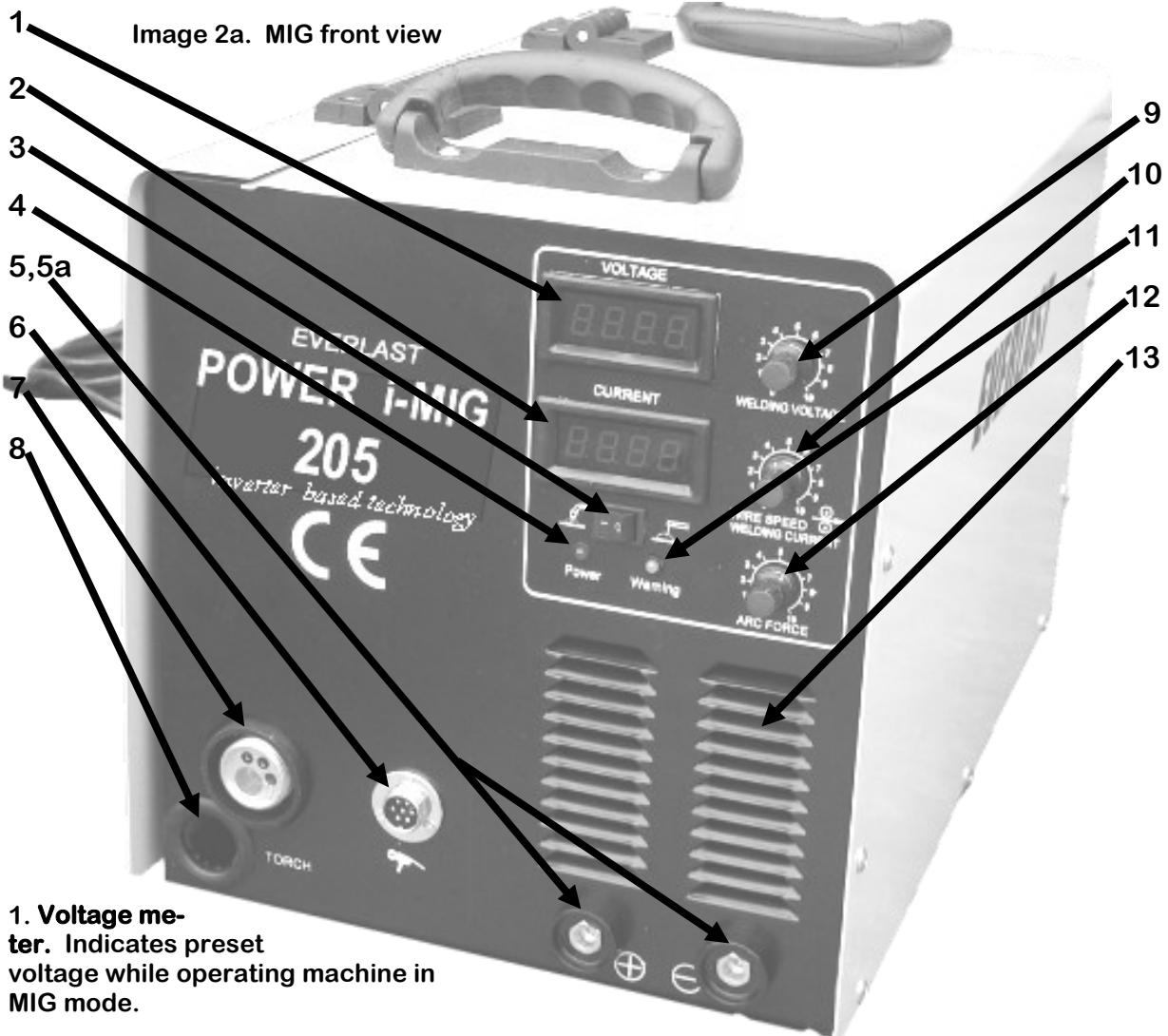

1. Voltage meter. Indicates preset voltage while operating machine in MIG mode.

2. Current Meter. Indicates preset current while in Stick (MMA, SMAW) mode.

3. MIG/MMA mode selector. Toggling switch to left selects MIG, to right MMA.

6. Spool gun port. Contact Everlast about purchasing a separate spool gun should you have need. This is offered as a option and can be used for welding aluminum and stainless steels.

continued

7. Euro style quick connect MIG gun coupling. This connection allows for rapid connection of MIG gun. Its design allows for easy interchange and use of other brands of MIG guns and accessories.



Image 2b MIG gun "Euro" style with electrode holder

8. MIG work cable and port. The unit is shipped with the cable tucked inside of the machine. The unit's cover must be lifted and cable routed through the front port pictured in image 2c so that the end of the coupling is able to be connected to lug. The cable coupling must be inserted into the positive female lug (+) for MIG. The ground cable is then plugged into the negative lug (-). When Stick (MMA, SMAW) is selected, the cable must be disconnected and replaced with the electrode holder (stinger) cable.



Image 2c. Machine set for MIG operation

9. Welding Voltage control. Turning clockwise increases the welding voltage while in the MIG mode.

10. Current control/wire speed control. Turning clockwise increases the amount of amperage used while welding. In MIG mode, wire feed rate modulates amperage by varying the arc length through manipulation of the wire speed rate. In Stick/MMA/SMAW mode, it increases the amperage output to allow for a "hotter" weld.

11. Over current/Overheat warning. When the machine has encountered an over current, this light illuminates. Over currents (overheating) are caused by exceeding the duty cycle or by a poor electrical power source. If this light is lit, stop welding immediately and allow the fan to cool the machine until the light goes out. Continued use of the unit with the over current light on can seriously damage it. Do not turn off the machine if over current occurs! The machine's fan must be allowed to continue to run. Only after the over current warning light goes out is it safe to shut off machine. Of course, if a hazardous situation arises, i.e. sparks, smoke, fire etc., turn the machine off immediately and unplug it, regardless of over current condition.

12. Arc Force Control. This feature allows you to change arc qualities. When used in MIG mode, it helps to control wire burn back and stick out. These two factors help in start/stopping activities such as spot welding. When used in Stick/MMA/SMAW mode, increasing or decreasing the "dig" can make the arc crisp and sharp or soft and buttery. This is helpful for making quality welds in and out of position. Some experimentation may be required to determine the best setting for individual tastes.

13. Fan cooling vents. Blocking these vents can cause eventual unit failure. Blocked or dirty cooling vents can also lead to frequent over current conditions. If over current conditions seem to be frequent, check the vents for dust, wasp nests, etc. To clean, removal of cover may be necessary. However, remember that there are electronic components inside. Unplug the machine first and then proceed to unscrew outer cover screws and carefully remove top cover, being mindful that the capacitors inside the machine store electricity even after the machine is shut down. These capacitors can discharge high voltage if touched. If you need assistance or feel uncomfortable performing this operation, contact EVERLAST SUPPORT.

continued

2.3 **Image 2.3a** is the rear of the machine. Each item is referenced by a number to a function or control with a following discussion of each item.

1. **Fuse.** If wire feed mechanism does not work or unit displays fails to illuminate, check fuse. Replace with 20A fuse only.

5. **Serial number.** Record and keep this number when referencing service issues with Everlast.

6. **Information label.** Necessary changes in specifications other than what may be found in this manual may occur. Check this label for supplemental information.

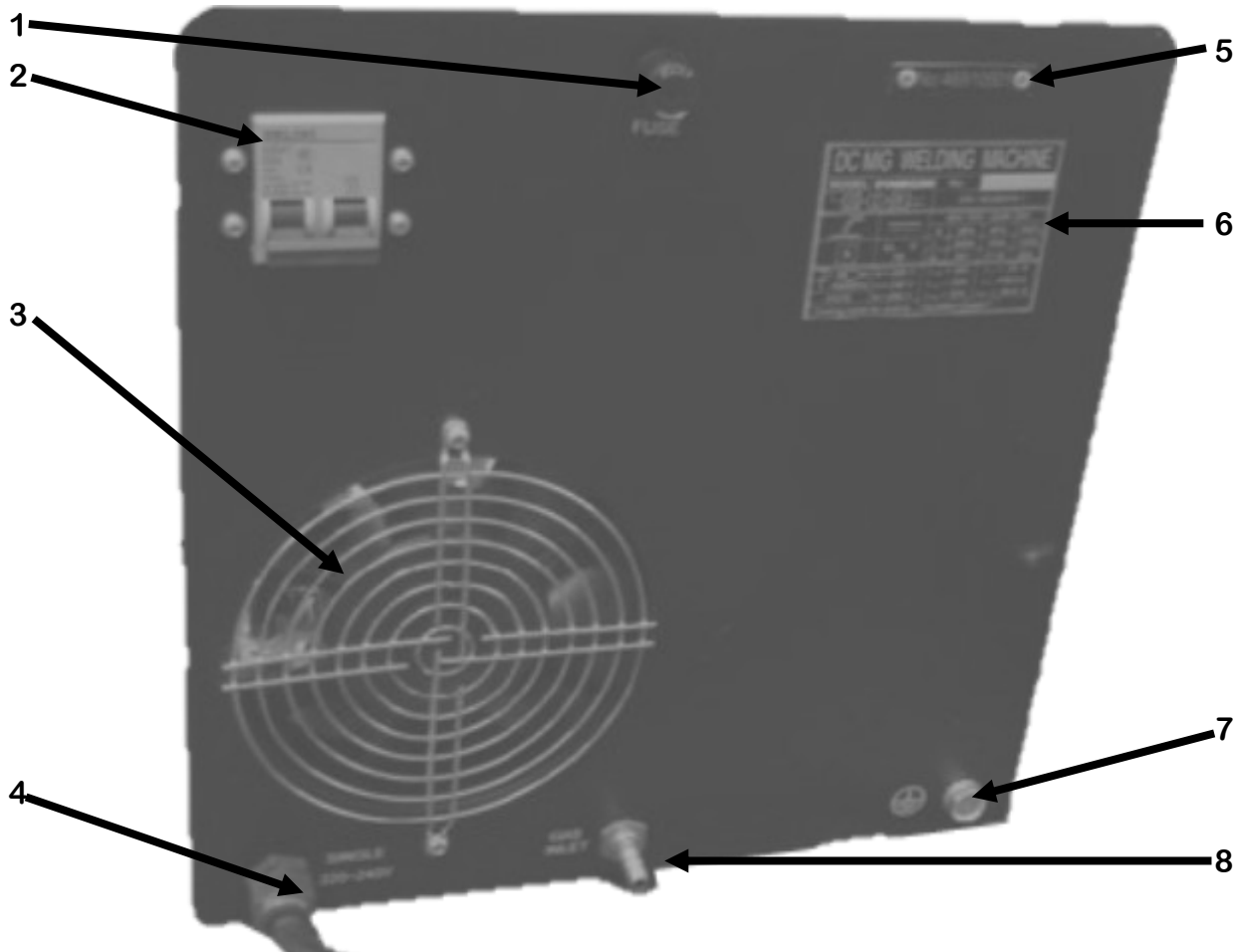

2. **Power switch.** Flip the switch up or down to turn on or off. The breaker style switch allows for heavy duty use and unit protection.

3. **Cooling Fan.** Make sure nothing obstructs fan. Keep guard in place and free of excess dust and build up.

4. **Power cord.** Make sure power cord is not burned, pinched, frayed or damaged.

7. **Grounding screw.** Although the unit is grounded through the cord, in some areas, codes may require an additional independent ground. Use this screw to ground unit with a separate wire to a separate ground. Consult your local electrical codes.

8. **Shielding Gas inlet.** Connect provided tubing to this line and secure it with a hose clamp. Connect the other end to the flow regulator (not supplied see section 3) and secure with clamp.

continued

2.3 The following images are pictures of the wire feeder mechanism. Each item is referenced by a number with an explanation of function and operation on the next page.

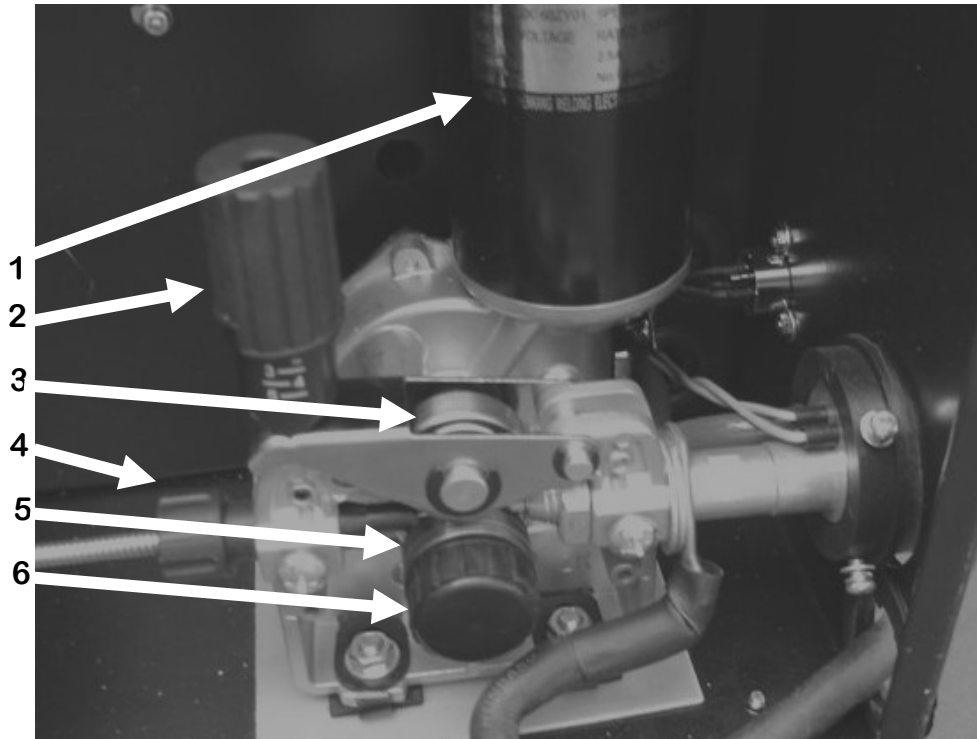

Image 2.3a

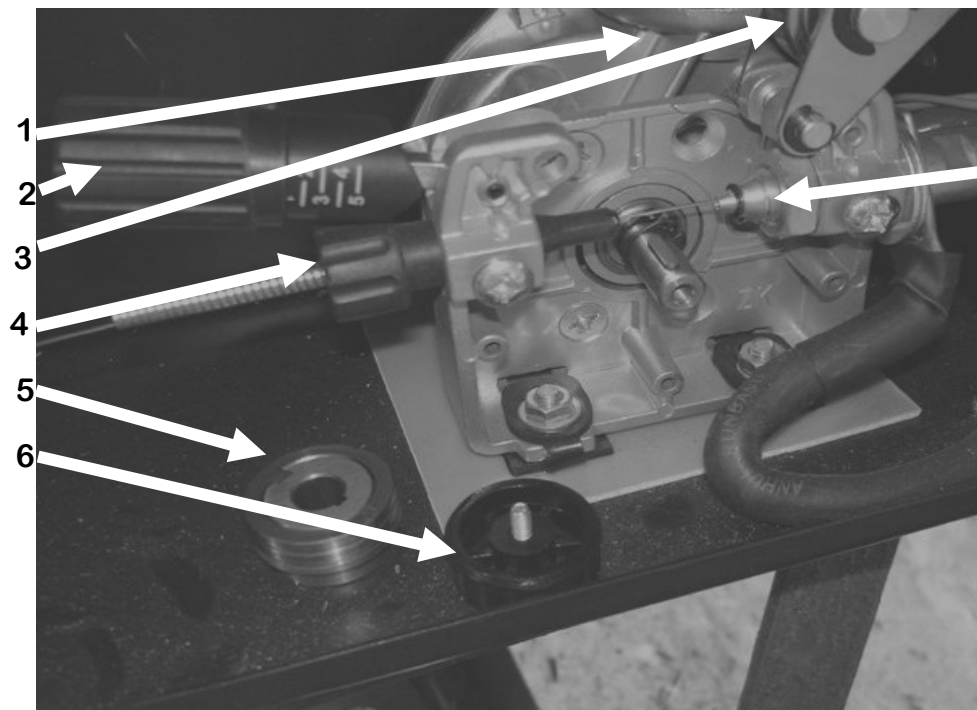

Image 2.3b

Powered side

continued

*Note: images 2.3 a and 2.3b are identically referenced by number to the same parts with differing views. Use image 2.3b for reference to this section and section 4.

1. Drive motor and feed assembly. If wire feeding mechanism stops and starts or otherwise feeds erratically with grinding or popping noises while in operation, check and repair the assembly if needed.

2. Pressure adjustment lever. Turning knob clockwise increases drive wheel pressure if slippage or poor feeding is observed. Do not over tighten as too much pressure may cause “birds nesting” of wire inside of MIG gun liner and accelerated wear of drive components.

3. Pressure roller. This roller holds pressure on the MIG wire as it is fed. Pressure is applied by the pressure adjustment lever. Check periodically to see that it rotates smoothly while feeding wire. If no rotation or if jerkiness is observed while wire is feeding, replace the roller. Over tightening pressure device lever can cause premature failure of the bearing or drive.

4. Inlet wire guide. Occasionally check for wear. Too much wear on cable can cause improper feeding. Replace cable if severe wear or damage has occurred to inlet guide. The use of commercial lubricating products, that include clip on lubrication pads that attach to the inlet wire guide, are recommended to help extend life of the wire guide and MIG gun liner. Do not use regular lubricating oil or grease! Consult your local welding supplier for recommendations on suitable lubrication products.

5. Drive roller. This roller engages the wire and is responsible for driving the wire to the end of the MIG torch. Notice that there are two grooves. One groove is slightly wider than the other. Use the smaller groove for .030 wire and the larger for .035 wire. Simply remove roller (see reference 6) and turn it around so that the correct groove lines up with the corresponding size wire. Make sure that the

slot on the drive roller correctly meshes with the woodruff key on the drive motor and feed assembly drive shaft. If wire seems to feed poorly or wire does not rest in groove, inspect grooves for particle build up or damage. Clean groove with a toothbrush if buildup is observed. Replace the roller if grooves are worn or damaged. Improper groove selection for the wire diameter can cause poor feeding symptoms and premature wear on drive roller. If wire feeding problems are observed after replacing a roll of welding wire, it is generally because of improper groove selection. Contact Everlast for alternative drive roller sizes and contact tips if smaller or larger wire is to be used.

6. Thumb retaining screw. Keep the thumb screw finger tight while welding or feeding wire. Do not over tighten it by using pliers or excessive hand pressure. Remove the thumb retaining screw only to allow the drive roller (5) to be removed when changing wire sizes or for cleaning or replacing drive roller.

3.1 These are general guidelines for use and maintenance for your I-MIG unit. Take into account all safety rules and recommendations first before operation and service. Do not let untrained personnel operate or service equipment in any way.

3.2 Shielding gas selection.

 Do not attempt to operate your unit with out proper shielding gas!

Proper MIG gas selection is crucial to satisfactory operation of your MIG machine. Shielding gas is usually a mixture or blend of two or more special gases designed to cover and protect your weld from contamination from the atmosphere while welding and as it cools. Oxygen and other gases from the atmosphere can infiltrate the weld and make it unserviceable. Do not be fooled by the weld's appearance, because many defects are contained inside the weld without the use of proper shielding gas. The most economical and available gas mixes are Argon and CO₂ mixes. Many mixtures with varying percentages of each gas are available. Generally, a 75% Argon/ 25% CO₂ mixture is the most versatile, economical and common mixture. Straight CO₂ is available and is cheaper, but is not recommended due to poorer quality welds and excessive spatter.

If you have never developed a working relationship with your local welding supplier, then it is time to make a visit to purchase or lease a tank of shielding gas. Many sizes of tanks are available. Choose the size that best fits your long term needs.

3.3 Regulator/ flow meter selection. You will need a flow meter/ regulator designed to be fitted onto your shielding gas tank. It controls the flow rate of shielding gas into your I-MIG. There are two styles generally available. The first has two gauges, one for pressure the other for flow. These are the least accurate, but usually the most economical. The best regulator has a pressure gauge and a flow meter with a ball that floats when gas flows.

 Always be sure to select the correct flow meter for the type of shielding gas that is in use. Never substitute oxygen or acetylene regulators!

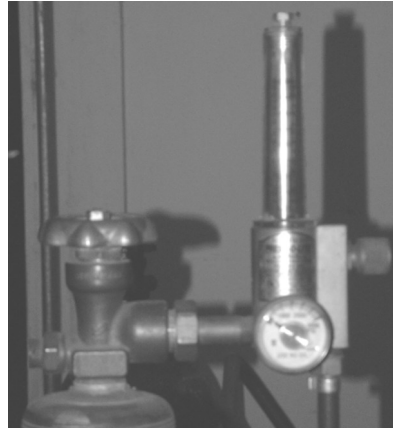

Image 3.3a Ball type flow meter

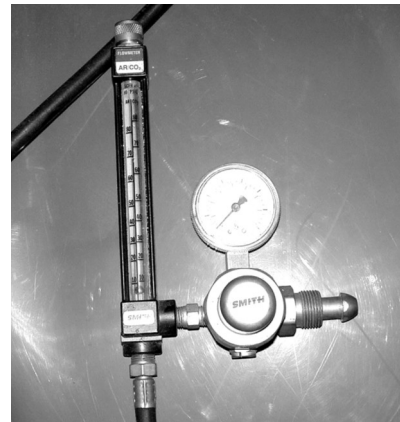

Image 3.3b Ball type flow meter

3.4 Regulator/Flow meter connection. After connecting regulator safely to tank, attach hose end to shielding gas inlet . (see 2.3 item 8) Firmly clamp and secure hose end to the unit. Depending upon the flow meter manufacturer, you may have to cut and remove the pre-crimped hose fitting to attach the hose to the shielding gas inlet barb. Open the tank valve slowly and gradually increase the regulator flow to check for leaks.

3.5. Regulator /Flow meter adjustment.

continued

Adjust flow meter per manufacturer's recommendations. Generally, the flow should be set around 15-25 CFH indoor. However, you will have to increase the flow of gas if weld porosity, sootiness, or weld discoloration is encountered. If a draft is present or welding is done outdoor, additional flow may be needed. Increase flow meter output until symptoms disappear.

3.6. Machine set up .

1. Plug installation. The I-MIG unit may or may not be equipped with a service plug. Due to the lack of standards concerning 220V wall plug configurations, Everlast may choose to ship the unit without a plug for wall service and to allow for permanent connection by a licensed electrician to the shop circuit panel. However, if you do not desire permanent connection of your unit, purchase of a 220V plug may be necessary. Many types and styles of 220V plugs may be purchased. Select a plug rated for at least 40 amps. Also determine plug prong pattern of the existing 220V outlets in your shop or garage. Make sure both plug and receptacle match perfectly. Do not force plugs to mate .

Since Everlast seeks to stay up to date with ever changing electrical manufacturing standards, the exact wire color may vary from time to time. *Generally*, a green wire may be recognized as the ground and a black or red wire as a "hot" leg as well as a white wire. To make a 220V circuit work, two "hot" wires must be used. Identify your ground wire first and properly attach the wire to the ground prong. The two remaining wires are your "hot" wires. Attach the two remaining wires to the remaining two prongs.

Although Everlast offers this information for your consideration, all local codes must be followed and it is recommended that you consult with a local licensed electrician if you are unsure of making the proper connection. Under no circumstances does Everlast encourage improper wiring techniques. If you have further questions, contact Everlast Support.

2. MIG Gun connection. Connect the gun to the machine by mating the gun fitting to the brass receptacle on the front of the machine. Make sure all the parts are fully engaged. Gently screw the collar on the gun fitting until it is snug. Do not over tighten. Make sure the ground cable is attached appropriately as discussed earlier in section 2.2.8.

3. Welding wire installation. Open the side cabinet and remove the collar that secures the roll of wire to the spool axle. Find the end of the wire on the roll and make sure that the roll will de-spool counterclockwise. This should make the wire feed directly into the wire feed mechanism. Do not allow the wire to feed clockwise from over the top of the spool into the wire feed mechanism. Install the wire on the axle post. Reinstall collar snugly but make sure that with gentle pressure, the spool of wire will still turn. If it will not turn, readjust collar. Trim the end of the wire. Refer to image 2.3 b. Flip the spring loaded pressure adjustment lever rearward as shown. To get the lever to move rearward, relieve pressure by rotating it counterclockwise until the lever easily slips backwards. Lift up the cage-like structure in which the top pressure roller is located. Slip the wire into the inlet wire guide. Push it through until it crosses the top of the drive roller. Make sure the wire lines up with the groove in the roller. Continue to feed the wire through the powered side. Continue to feed the wire manually until it reaches into the gun cable. Lower the top pressure roller onto the wire, making sure it depresses the wire fully into the groove on the drive roller. Flip the drive pressure adjustment lever back into its detent and make sure it is completely seated. Slowly rotate the top of the lever clockwise until the pressure is sufficient to feed the wire into the gun. Turn on the machine (leave gas off at this time). Press the MIG gun switch. The wire feeding mechanism should begin to operate. Hold switch until 1 inch or more of wire protrudes out of the gun nozzle. Adjust pressure to ensure smooth feeding of

continued

the of wire. If an excessive roll-off of wire is observed, tighten spool collar to keep wire roll-off to a minimum. Excessive roll-off of wire can lead to jerky and inconsistent feeding. Do not over tighten the wire spool. Close and fasten cabinet. Do not weld with the machine if cabinet door is open.

Image 3.6
Spool retaining collar.

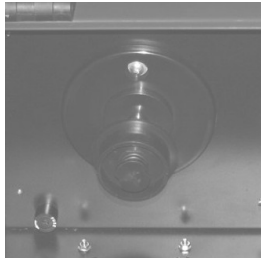

3.7 Machine Operation. MIG: Select switch for MIG operation.

1. After wire is installed and properly adjusted, turn on the shielding gas. Press and hold the trigger on the MIG gun. A click should be heard in the machine, wire should feed off smoothly and a gentle hiss of gas flow should be heard coming from the nozzle. Refer to 3.5 for proper flow adjustment.

2. Carefully trim to 1/4" any excess wire that is sticking out of the MIG gun nozzle. Too much stick out will result in push-off when beginning a weld and will result in poor weld quality. Too little stick out when beginning a weld could result in the fusing of the wire to the tip and will require nozzle and contact tip removal and possible replacement of contact tip.

3. Attach the ground clamp to the work piece. Make sure that the ground clamp is making good contact. Slight sanding or grinding of the work piece may be necessary. If the ground arcs during the welding process, it is usually due to poor contact.

4. A medium or half way setting of all controls will help you to find the appropriate setting for the initial weld. If the weld seems ropy or piles up on the metal, decrease the wire feed rate. If this does not correct the problem, increase voltage. If the weld burns through, decrease voltage. If it continues to burn through, lower the

wire speed. Always select voltage first, then adjust wire speed within the set voltage adjustment. This method will find the appropriate wire speed setting for the given voltage. It is advisable that a written record of these settings be kept for future usage. There is no set way of determining the correct wire speed, voltage adjustment and arc force for each weld. There are many variable factors involved when determining the correct weld settings. Here are a few things to consider:

1. Thickness of metals being joined.
2. Shielding gas mixture used.
3. Flow rate of gas.
4. Welding wire diameter.
5. Operator skill.

Each variable plays into the machine setting. Experienced welders also realize that for two identical machines, the settings may be slightly different as each machine has its own weld characteristics.

5. Make sure the nozzle is perpendicular to the weld, from side to side so that both sides of the weld will receive equal heat. In the direction of travel, the nozzle must be slightly angled forward or back. (While, the gun angle will vary with the welding positions, be sure to keep the weld arc is visible.) Keeping the gun nozzle about 1/2 inch from the weld surface, grip the handle securely and press the trigger. You may lower the gun slightly as the arc initiates. Do not allow the nozzle to contact the surface. A slight push-off of the gun may be felt for first time or two. You should see an arc and hear a steady and crisp frying sound. If the sound is slow and the wire is popping and breaking arc rather than steadily melting, increase the voltage or decrease the wire speed. Watch the molten puddle form in front of the gun and move slowly forward and watch the puddle as it begins to cool behind the gun. Make sure the weld is even and slightly convex.

6. Anti-spatter spray or nozzle dip may be needed to prevent spatter from sticking to the MIG nozzle and work piece. Obtain both from your local welding supplier.

continued

3.8 Machine operation. MMA/Stick (SMAW)
Select switch for MMA operation.

1. Make sure the ground cable is properly secured in the appropriate machine lug. Connect ground clamp to the work piece. Ensure that the ground clamp is making good contact with the work piece. A light sanding or grinding of the work piece may be necessary if it is rusty or painted.

2. Insert electrode into electrode holder. Position the electrode for the most comfortable position so that the electrode can be held directly over the work piece with a slight angle.

3. Strike an arc by swiping it briskly across the work piece in the same manner as one would strike a match. Alternatively, you may strike an arc with firm tapping motion against the work piece. Either method is acceptable. An arc should initiate. Continue to keep the arc going by holding the electrode off the work piece a little over 1/8 of an inch. Continue the arc by feeding the electrode into the weld puddle while moving the electrode forward. This will take some coordination, but will be fairly easy to do after practice. Do not allow the arc to become too long, because air and slag can become entrapped in the metal. The sound of a proper arc will be similar to a gentle frying sound. A long arc will emit a humming sound. An arc that is too short may be extinguished and the electrode may stick to the work piece. If the electrode sticks, immediately release the electrode from the electrode holder and break the electrode loose by hand. If the flux has broken away from the electrode, trim it down to the flux or discard the electrode.

4. Use the Arc force and current control to adjust arc qualities. Adjust the amperage according to the recommendations of the electrode (welding rod) manufacturer for the type and size of the electrode used. Too high of an amperage will result in overheating of the base metal. Too low of an amperage will result in poor weld quality.

The arc force will affect how crisp the arc is whether it is smooth and buttery or deeply penetrating. Use it to suit the desired weld finish. Experimentation will be required to find the optimal setting desired.

5. Electrode selection. Electrodes are usually given performance and characteristic ratings using a system of letters and numbers determined by the American Welding Society (AWS). The rating system includes the minimum tensile strength of the finished weld, the weld position (flat, vertical, horizontal, or overhead or a combination of two or more positions) and the flux type. Additional information may be given. Each manufacturer has their individual name and terminology as well. There is no general recommendation to be made about electrode selection, except for practice welds, a electrode designated by the AWS as E 6011, E 6013, E 7014, or E 7018 may be used. These are among the most common electrodes used in the industry and are not difficult to find. E 6011 electrodes are not as smooth running as some of the other electrodes, but offer the advantage of being used on rusty metal and contaminated surfaces. It is widely used and requires very little skill to begin with. This is not a particular endorsement of an E6011, rather a simple example of what may be used in developing proficient technique. It is recommended that a variety of electrodes be used and practiced with. Consultation with an experienced local welding supplier will help greatly in determining what welding electrode is the best for your given situation. Many times, samples or small packages of electrodes are available at relatively low cost to determine for yourself the best electrode to use. **Be sure to observe the manufacturer recommendations regarding polarity.** If the weld appears lumpy, porous or otherwise malformed, change the polarity of the ground cable and the electrode holder cable. Many electrodes run with a reverse, (DCEP) setting. A few may run with a straight polarity (DCEN) only. Some will run either way.

SECTION 4**TROUBLE SHOOTING**

TROUBLE:	CAUSE/SOLUTION
Machine will not turn on.	Check cords and wiring. Check circuit breaker. If no fault is found, contact Everlast Support.
Machine runs, but will not weld in either mode.	Check for good ground. Make sure ground cable and MIG gun is securely fastened to lug and receptacle. Check that the switch is correctly selected for MIG or MMA.
Machine welds, but displays will not illuminate.	Check machine fuse. Contact Everlast Support for further remedy.
MIG wire does not feed smoothly.	Adjust tension pressure on drive roller. Check for proper feeding of wire off of spool. If rough feeding is observed while welding, increase wire speed.
MIG wire burns back into nozzle.	Check and adjust stick out. Decrease weld voltage or increase wire speed. Adjust arc force. Check for empty wire spool. Contact tip may be worn, replace.
MIG Wire bird nests or balls up in liner or in the machine.	Reduce tension on drive pressure assembly. Increase voltage, or increase wire size. Check liner for wear or damage. Replace if necessary. Check for damaged contact tip.
Weld quality is poor. Weld is dirty/oxidized.	Eliminate drafts. Check if there is sufficient shielding gas left in tank. Check gas flow. Adjust for higher flow of gas. Listen for audible click of gas solenoid. If no click is heard, then contact Everlast Support.
Will not operate in MMA.	Check that MMA has been selected. Make sure cables are securely in lugs. Make sure of good ground.
Weld quality is poor in MMA.	Check and adjust settings. Adjust polarity settings per electrode manufacturer.
Over current LED illuminates.	Duty cycle exceeded. Allow machine to cool. Make sure fan is not blocked.
MIG arc is unstable.	Check liner for wear, damage. Replace.
Other issues.	Contact Everlast support.

MIG Gun for Everlast I-MIG Series

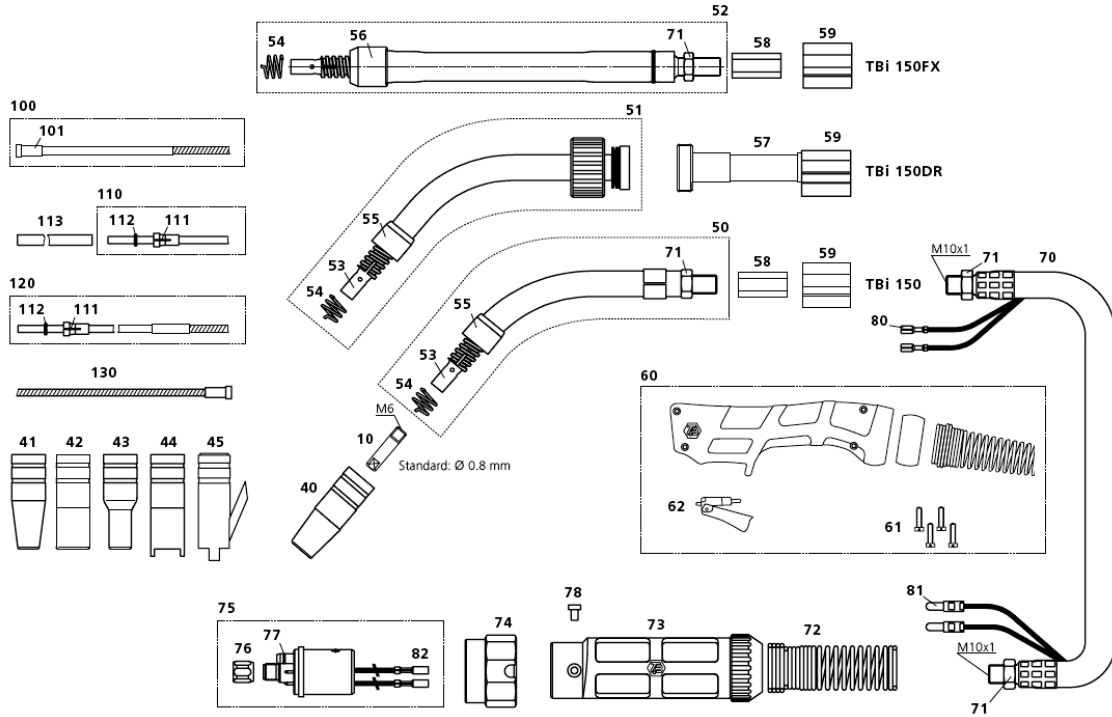

Pos.	Description	Part. No.	Pos.	Description	Part. No.
Contact tips					
▶ 10	Contact tip M6x25, Ecu	340P__1073*	72	Spring support small 16-50 sqmm	600P102099
10	Contact tip M6x25, CuCrZr	340P__3073*	73	Cable support cpl. (2 pieces)	701P001045
10	Contact tip M6x25 Alu, Ecu	341P__1073*	74	PVC adaptor nut	701P002081
Gas nozzles					
▶ 40	Nozzle con. diam. 12.0 mm	345P012002	75	Central adaptor ESG cpl., 2 poles, moveable pins	701P001048
40	Nozzle con. diam. 12.0 mm long insul.	345P012402	76	Sleeve nut M10x1	701P002005
41	Nozzle con. diam. 9.5 mm	345P013002	77	O-ring 4.0x1.0 mm (gas nipple)	365P100040
42	Nozzle cyl. diam. 16.0 mm	345P011002	78	Slotted screw M4x6	100P008401
42	Nozzle cyl. diam. 16.0 mm long insul.	345P011402	80	Cable lug, flat	375P000023
43	Nozzle bottle form diam. 12.5 mm	345P014002	81	Insulated connector, male, round	375P000004
44	Spot weld nozzle diam. 16.0 mm long insul.	345P015402	82	Insulated connector, female, round	375P000003
45	Nozzle for nails diam. 16 mm	345P015502	Wire guides		
Spare parts					
50	Torch neck TBi 150, 50°	102P001002	100	Liner w/ insulation white (x.40 m) for wire 0.6-0.9	324P1338_4*
51	Torch neck TBi 150 DR (swivel), 45°	102P001029	▶ 100	Liner w/ insulation blue (x.40 m) for wire 0.8-1.0	324P1545_4*
52	Torch neck TBi 150 FX (flexible)	102P001021	101	Collet for liner 1.3x3.8 mm	330P015040
53	Nozzle support TBi 150 w/o spring	102P002037	101	Collet for liners dia. 4.5 mm	330P025045
54	Nozzle spring TBi 140/145/150	102P002011	110	Teflon liner blue (x.50 m) for wire 0.6-0.9	326P1540_5*
55	Head insulator TBi 140/145/150	102P002003	111	Collet for teflon and PA liner 2.0x4.0 mm	331P020040
56	Head insulator TBi 150 FX	102P002036	112	O-ring 3.50x1.50 mm (teflon liner)	365P150035
57	Support for DR necks	600P101045	113	Support tube 5x4.4 mm, L=150 mm	329P544150
58	Hex brass body M10x1	600P002126	120	PA-Alu wire guide (x.50 m) for wire 1.0-1.2	328P2040_A*
59	PVC body	600P002017	130	Liner for TBi DR Torch necks	322P204005
60	Handle blue, aircooled, cpl. kit	380P220400			
61	Cross recessed screw M 3.5x14	100P008413			
62	Trigger, red, 2 poles	385P021016			
70	TBi-Flex coaxial cable 16 sqmm	360P1611_0*			
71	Hex nut M10x1	101P002005			

Contact your Everlast dealer for genuine OEM parts and accessories. Please have the serial number and model number ready when ordering parts or accessories.